

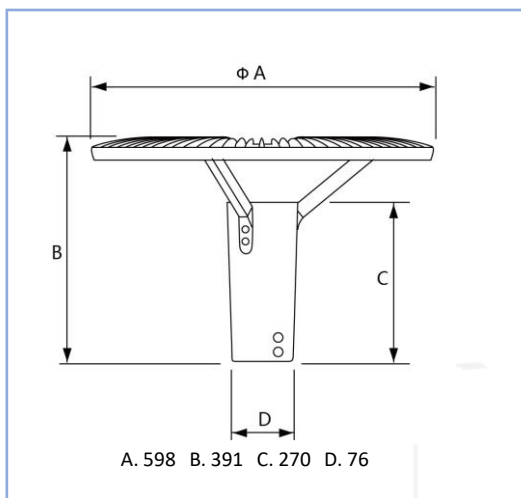

פנס פלנטה

תיאור: תאורה דקורטיבית אורבנית
מקט: PY-LEDGD100
צבע: אפור גרפיט
חומר: יציקת אלומיניום, צביעה אלקטרוסטטית
סוג נורה: LED
הספקים: 50W
מותאם להתקנה: בראש עמוד 2.5-2"
מותאם לגובה: 3-5 מטר

נתונים טכניים



50w	הספקים
3000K / 4000K	גוון האור
140 lm/W	יעילות אורית
>80	CRI
IP66	דרגת אטימות
IK08	דרגת הגנה מפני פגיעות מכניות
45C° עד -30C°	טמפרטורת עבודה
PHILLIPS LED	יצרן הLED
PHILLIPS	דרייבר
ללא	תקשורת
220-240V , 50/60Hz	מתח עבודה



אפשרויות פוטומטריות

● Luminous Intensity Distribution Diagram

The Elux series LED street light luminaire come with a robust optic compartment design, enable many different options of LED chipset and optic lens modules, which will help customers to always cope with the latest development of efficiency of led by using different type of led package, from 3030, 3535 to 5050.

Option 1: with 3535 LED package, basically the Elux could offer 6 standard light distribution curves as following

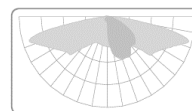
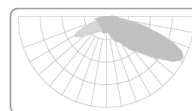
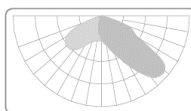
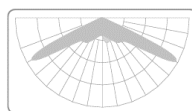
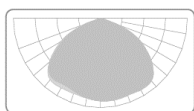
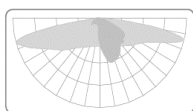
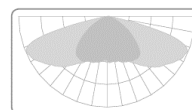
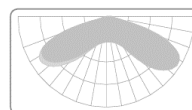
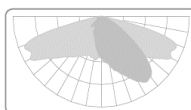
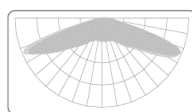
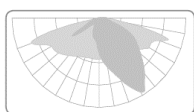
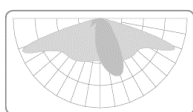

Option 2: with 5050 LED package, basically the Elux could offer 18 standard light distribution curves as following

