



## פנס מון סטאר 2 רגליים

**תיאור:** תאורה דקורטיבית אורבנית

**מקט:** PY-CG01A

**צבע:** אפור גרפיט/שחור/לפי צבע RAL

**חומר:** יציקת אלומיניום, צביעה אלקטרוסטטית

**סוג נורה:** LED

**הספקים:** 30W-120W

**מותאם להתקנה:** בראש עמוד 2.5-2"

**מותאם לגובה:** 4-12 מטר

## נתונים טכניים

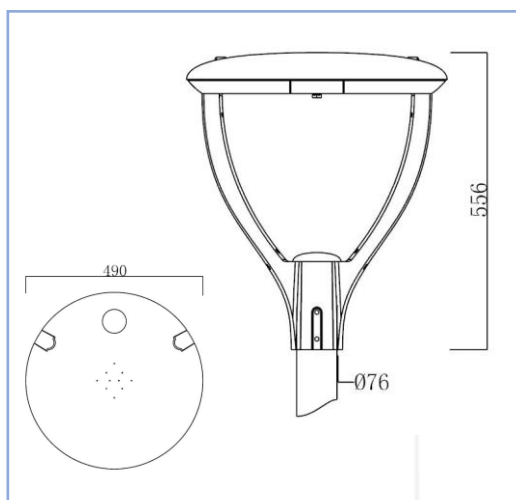

30-120w	הספקים
3000K / 4000K	גוון האור
150 lm/W	יעילות אורית
>70	CRI
IP66	דרגת אטימות
IK08	דרגת הגנה מפני פגיעות מכניות
55°C עד -30°C	טמפרטורת עבודה
PHILLIPS LED	יצרן הLED
PHILLIPS	דרייבר
DALI, NEMA, PWM אפשרות ל:	תקשורת
220-240V, 50/60Hz	מתח עבודה



## אפשרויות פוטומטריות

### ● Luminous Intensity Distribution Diagram

The Elux series LED street light luminaire come with a robust optic compartment design, enable many different options of LED chipset and optic lens modules, which will help customers to always cope with the latest development of efficiency of led by using different type of led package, from 3030, 3535 to 5050.

Option 1: with 3535 LED package, basically the Elux could offer 6 standard light distribution curves as following

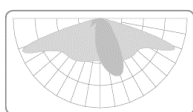

C15034 STRADELLA-8  
XT-E/XP-G2/XP-G3

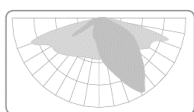

C15035 STRADELLA-8 T3  
XT-E/XP-G2/XP-G3

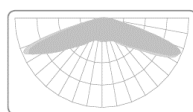

C15481 STRADELLA-8  
XT-E/XP-G2

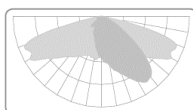

C14165 STRADA-2X2-  
ME-WIDE2

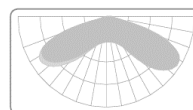

C14680 STRADA-2X2-  
VSM

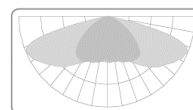

C14750 STRADA-2X2-  
CAT

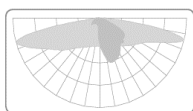

C15677 STRADELLA-8  
XT-E/Osion Square Gen3

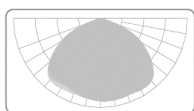

C15920 STRADELLA-8  
XT-E

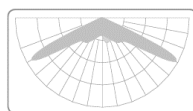

C16005 STRADELLA-8 T1  
XT-E/XP-G2/XP-G3

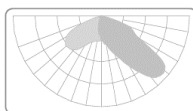

C14896 STRADA-2X2-  
PXL

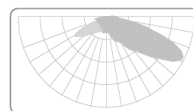

C15014 STRADA-  
2X2-T4

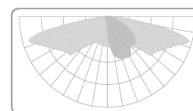

C15021 STRADA-2X2-  
SCL

Option 2: with 5050 LED package, basically the Elux could offer 18 standard light distribution curves as following

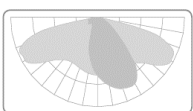

C12362 STRADA-2X2-DWC

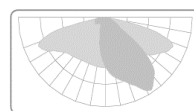

C13299 STRADA-2X2-ME

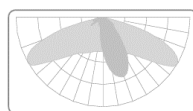

C13300 STRADA-2X2-T2

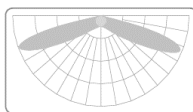

C15135 STRADA-  
2X2-T1

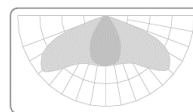

C15217 STRADA-2X2-  
CAT-B

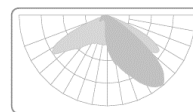

C15594 STRADA-2X2-  
MEW

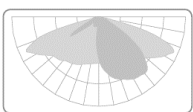

C13301 STRADA-2X2-T3

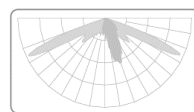

FP15589 STRADA-  
2X2MXS-T2

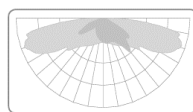

C13858 STRADA-2X2-XW

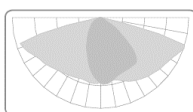

155-70 Type II Medium

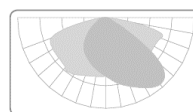

150-80 Type III Medium

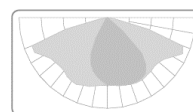

150-75 Type II Short

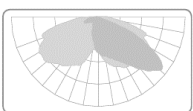

C15687 STRADA-2X2-EW

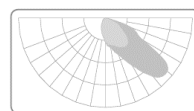

C14116 STRADA-2X2-PX

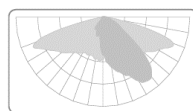

C14164 STRADA-2X2-  
ME-WIDE1

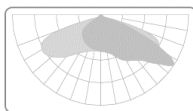

145-60 Type III Short

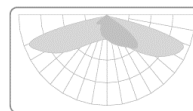

155-45 Type II Medium

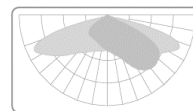

155-60 Type III Medium